

**PFAFF**  
Perfection starts here.™

select line



Owner's manual

This household sewing machine is designed to comply with IEC/EN 60335-2-28 and UL1594.

# IMPORTANT SAFETY INSTRUCTIONS

When using an electrical appliance, basic safety precautions should always be followed, including the following:

Read all instructions before using this household sewing machine.

## **DANGER** - To reduce the risk of electric shock:

- A sewing machine should never be left unattended when plugged in. Always unplug this sewing machine from the electric outlet immediately after using and before cleaning.

## **WARNING** - To reduce the risk of burns, fire, electric shock, or injury to persons:

- This sewing machine is not intended for use by persons (including children) with reduced physical, sensory or mental capabilities, or lack of experience and knowledge, unless they have been given supervision or instruction concerning use of the sewing machine by a person responsible for their safety.
- Children should be supervised to ensure that they do not play with the sewing machine.
- Use this sewing machine only for its intended use as described in this manual. Use only attachments recommended by the manufacturer as contained in this manual.
- Never operate this sewing machine if it has a damaged cord or plug, if it is not working properly, if it has been dropped or damaged, or dropped into water. Return the sewing machine to the nearest authorized dealer or service center for examination, repair, electrical or mechanical adjustment.
- Never operate the sewing machine with any air openings blocked. Keep ventilation openings of the sewing machine and foot controller free from the accumulation of lint, dust, and loose threads.
- Keep fingers away from all moving parts. Special care is required around the sewing machine needle.
- Always use the proper needle plate. The wrong plate can cause the needle to break.
- Do not use bent needles.
- Do not pull or push fabric while stitching. It may deflect the needle causing it to break.
- Wear safety glasses.
- Switch the sewing machine off ("0") when making any adjustment in the needle area, such as threading needle, changing needle, threading bobbin, or changing presser foot, etc.
- Always unplug the sewing machine from the electrical outlet when removing covers, lubricating, or when making any other user servicing adjustments mentioned in the instruction manual.
- Never drop or insert any object into any opening.
- Do not use outdoors.
- Do not operate where aerosol (spray) products are being used or where oxygen is being administrated.
- To disconnect, turn all controls to the off ("0") position, then remove plug from outlet.
- Do not unplug by pulling on cord. To unplug, grasp the plug, not the cord.

## **SAVE THESE INSTRUCTIONS**

# Contents

## Introduction

Parts of your select™ sewing machine	4
Standard accessories	5
Stitch overview	6
Stitch table - Non-elastic	6-7
Stitch table - Stretch stitches	8-9

## Operate your sewing machine

Lid	10
Connecting the foot control	10
Main switch	10
Accessory tray	11
Using the free arm	11
Bobbin winding	12-15
Changing the bobbin	16
Threading	17-18
<i>Needle Threader (Model 4.2)</i>	18
<i>Threading the twin needle</i>	18
Bringing up the bobbin thread	19
Thread cutter	19
Presser foot lifter	20
Changing the presser foot	20
The IDT™ system (Integrated Dual Feed)	21
Setting the needle thread tension	22
Dropping the feed dog	22
Changing the needle	22
Stitch width dial	23
Needle position dial	23
Reverse sewing	24

Stitch length adjustment dial	24
<i>Adjust stitch length</i>	24
<i>Buttonhole</i>	24
<i>Stretch stitches</i>	24
Stitch selection - Easy Select System	25
<i>Utility stitches</i>	25
<i>Stretch stitches</i>	25
<i>Utility and stretch stitch combinations</i>	25

## Utility stitches and practical sewing

Explanation of the sewing chart	26
Needle thread tension	27
Topstitching	27
Straight stitch	28
Zigzag stitch	28
Blindhem stitch	29
Overlock stitch	30
Elastic stitch	31
Stabilizing edges	31
Hemming with the twin needle	32
Buttonholes	33-34
Free Motion Sewing	35
Sewing on buttons	35-36
Sewing on zippers	36

## Maintenance and trouble-shooting

Changing the needle plate	37
Cleaning and oiling	37
Trouble-shooting	38-39

## Parts of your select™ sewing machine

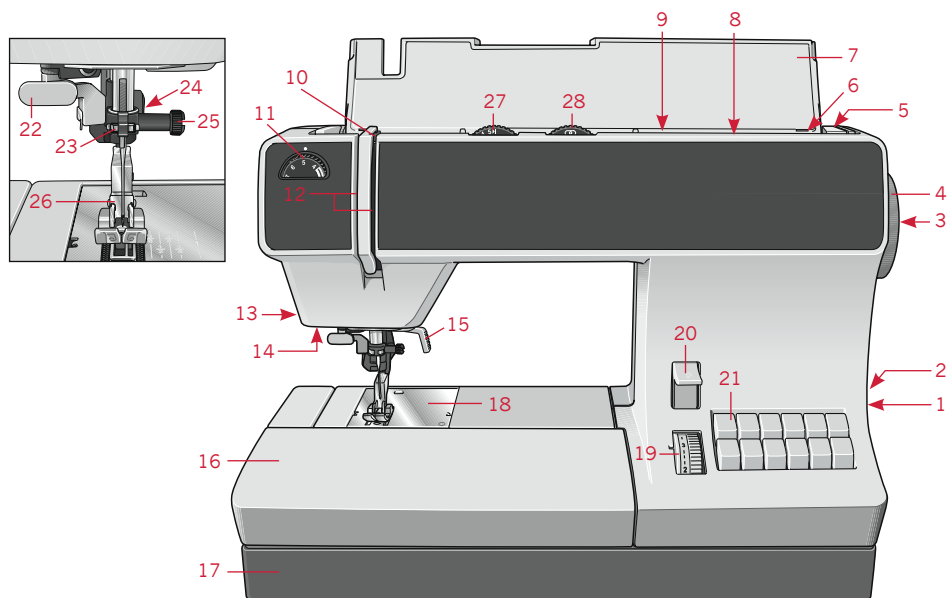

- |   |   |
|---|---|
| 1 Main switch                                     | 16 Removable accessory tray                     |
| 2 Connection socket "foot control with main cord" | 17 Base plate                                   |
| 3 Handwheel release disk                          | 18 Needle plate                                 |
| 4 Handwheel                                       | 19 Stitch length dial                           |
| 5 Carrying handle                                 | 20 Button for "reverse sewing"                  |
| 6 Bobbin winder                                   | 21 Stitch selection                             |
| 7 Lid with stitches                               | 22 Needle threader (4.2)                        |
| 8 Extra spool pin                                 | 23 Thread guide                                 |
| 9 Spool pin with spool cap                        | 24 IDT™ system / Integrated Dual Feed (4.2/3.2) |
| 10 Take-up lever                                  | 25 Needle holder with fixing screw              |
| 11 Needle thread tension dial                     | 26 Presser foot holder with presser foot        |
| 12 Threading path                                 | 27 Stitch width dial                            |
| 13 Thread cutter                                  | 28 Needle position dial                         |
| 14 LED lights                                     |   |
| 15 Presser foot lifter                            |   |

## Standard accessories

For more information about accessories, please contact your PFAFF® dealer.

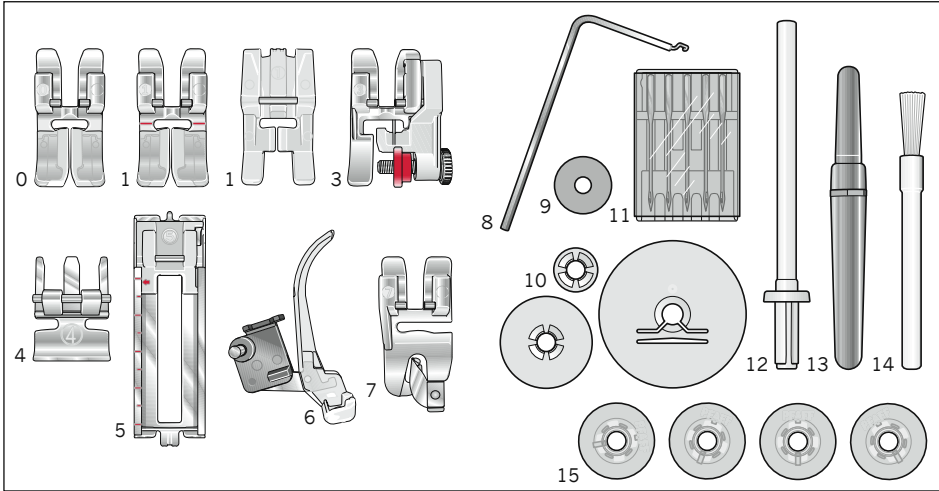

### 0 Standard Presser Foot

With IDT™ system (pictured)  
select™ 4.2 and 3.2

Without IDT™ system  
select™ 2.2

### 1 Fancy Stitch Foot

With IDT™ system  
select™ 4.2

### 1 Clearview Foot

(Fancy-stitch foot without IDT™  
system)

### 3 Blindhem/Overlock Foot

With IDT™ system (pictured)  
select™ 4.2 and 3.2

Without IDT™ system  
select™ 2.2

### 4 Zipper Foot

With IDT™ system (pictured)  
select™ 4.2 and 3.2

Without IDT™ system  
select™ 2.2

### 5 Buttonhole Foot

### 6 Darning Foot

select™ 4.2

### 7 Rolled Hem Foot, 3 mm

With IDT™ system  
select™ 4.2

### 8 Edge Guide/Quilting Guide

### 9 Felt pad

### 10 Spool caps, small/medium/large

### 11 Needles

### 12 Extra spool pin

### 13 Seam ripper

### 14 Brush

### 15 Bobbins

## Stitch overview

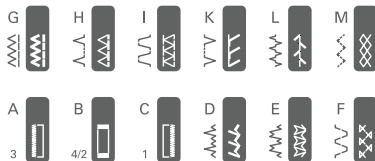

### select™ 4.2

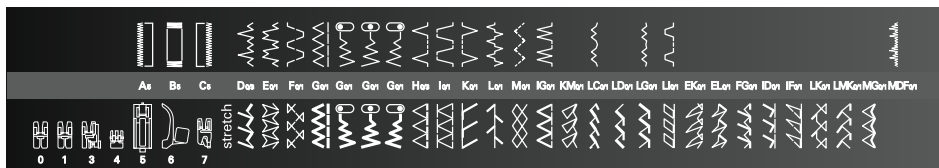



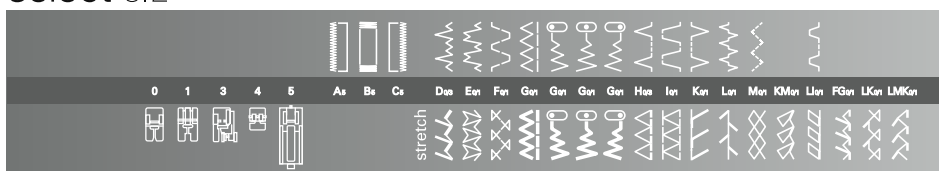

### select™ 3.2

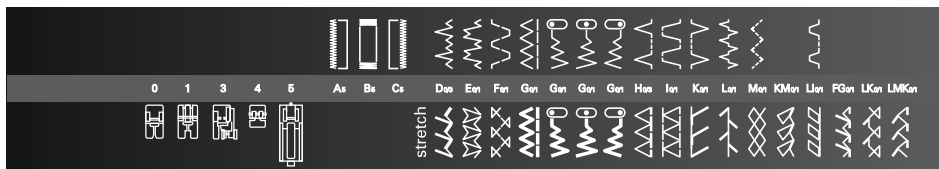





















### select™ 2.2























## Stitch table - Non-elastic stitches













Stitch	Presser Foot		Application	
	4.2	3.2/2.2		
	A/B/C	A/B/C	5	Standard buttonhole for blouses or bed linen .
	D	D	0/3	For invisible hemming with simultaneous seam/overcasting. Especially for stretch material.
	E	E	0/1	A traditional decorative stitch e.g. for towel borders.
	F	F	0/1	A traditional decorative stitch e.g. for towel borders.

Stitch			Presser Foot	Application
	4.2	3.2/2.2		
	<b>G</b>	<b>G</b>	<b>0/1</b>	For all straight stitching and topstitching work up to 6 mm For serging and appliqué. Also suitable for tapering, eyelet embroidery and cording work.
			<b>0/1</b>	Straight stitch: For all sewing and top-stitching operations which require a left needle position. Zigzag stitch: For serging, appliqué and tapering.
			<b>0/1</b>	Straight stitch: For most sewing and top-stitching operations. Zigzag: for most zigzag operations.
			<b>0/1</b>	Straight stitch: For all sewing and top-stitching operations which require a right needle position. Zigzag stitch: For serging, appliqué, tapering and cording work.
	<b>H</b>	<b>H</b>	<b>0/3</b>	For invisible hemming on woven materials.
	<b>I</b>	<b>I</b>	<b>0/1</b>	A traditional decorative stitch.
	<b>K</b>	<b>K</b>	<b>0/3</b>	For flat overlapped seams.
	<b>L</b>	<b>L</b>	<b>0/1</b>	For overcasting, sewing on elastic, darning tears and inserting patches.
	<b>M</b>	<b>M</b>	<b>0/1</b>	For overcasting, sewing on elastic, darning tears and inserting patches.
	<b>IG</b>	-	<b>0/1</b>	A traditional decorative stitch.
	<b>LC</b>	-	<b>0/1</b>	A dainty decorative stitch.
	<b>LG</b>	-	<b>0/1</b>	A dainty decorative stitch.
	<b>LI</b>	<b>LI</b>	<b>0/1</b>	A traditional decorative stitch.
	<b>MDF</b>	-	<b>0/1</b>	A traditional decorative stitch.

## Stitch table - Stretch stitches

Stitch	Presser Foot		Application
	4.2	3.2/2.2	
	<b>D</b>	<b>D</b>	<b>0/1</b> Elastic closing and serging seam. The material must be turned by 180 degrees.
	<b>E</b>	<b>E</b>	<b>0/1</b> For top-stitching and overstitching stretch materials, e.g. cuffs, hems and panels.
	<b>F</b>	<b>F</b>	<b>0/1</b> A decorative stitch for top-stitching or whip stitching hems, e.g. pajamas and sweatsuits.
	<b>G</b>	<b>G</b>	<b>0/1</b> For stretch seams, e.g. inside seams as well as seams on sportswear and workwear. For sewing elastic bands on elastic materials or seams on stretch materials.
			<b>0/1</b> For elastic seams which require a left needle position.
			<b>0/1</b> For elastic seams which require a center needle position.
			<b>0/1</b> A traditional decorative stitch e.g. for towel borders.
	<b>H</b>	<b>H</b>	<b>0/1</b> Elastic closing and serging seams for jersey. The material must be turned by 180 degrees.
	<b>I</b>	<b>I</b>	<b>0/3</b> A closing and serging seam for materials which fray easily.
	<b>K</b>	<b>K</b>	<b>0/3</b> A closing and serging seam for sturdy materials or materials which do not fray easily.
	<b>L</b>	<b>L</b>	<b>0/1</b> For joining two finished edges with a gap between, e.g. hemstitching. Also for crazy quilting.
	<b>M</b>	<b>M</b>	<b>0/1</b> For sewing on elastic thread, overstitching terry.
	<b>IG</b>	-	<b>0/1</b> A decorative stitch also used as a covering stitch.
	<b>KM</b>	<b>KM</b>	<b>0/1</b> A loose decorative stitch.



Stitch			Presser Foot	Application
	4.2	3.2/2.2		
	<b>LC</b>	-	<b>0/1</b>	A decorative stitch, e.g. for household textiles.
	<b>LD</b>	-	<b>0/1</b>	A decorative stitch, e.g. for household textiles.
	<b>LG</b>	-	<b>0/1</b>	A decorative stitch, e.g. for traditional embroidery.
	<b>LI</b>	<b>LI</b>	<b>0/1</b>	An ornamental stitch, e.g. for bath accessories.
	<b>EK</b>	-	<b>0/1</b>	A decorative stitch, e.g. for household textiles.
	<b>EL</b>	-	<b>0/1</b>	For top-stitching and overstretching stretch materials, i.e. cuffs, hems and panels.
	<b>FG</b>	<b>FG</b>	<b>0/1</b>	A top-stitching seam for patchwork and quilting.
	<b>ID</b>	-	<b>0/1</b>	A decorative elastic stitch, e.g. for sportswear.
	<b>IF</b>	-	<b>0/1</b>	A decorative, elastic stitch. For whip-stitching hems, e.g. on pajamas and sweatsuits. The material must be turned by 180 degrees.
	<b>LK</b>	<b>LK</b>	<b>0/1</b>	A decorative, elastic stitch.
	<b>LMK</b>	<b>LMK</b>	<b>0/1</b>	A decorative, elastic stitch.
	<b>MG</b>	-	<b>0/1</b>	A decorative, elastic stitch.

## Lid

Open the folding lid (7) upwards. The stitches of the sewing machine are illustrated on the inside of the lid.

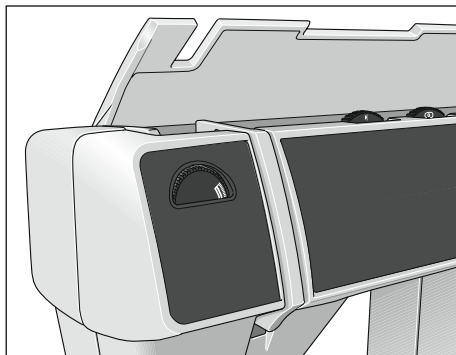

## Connecting the foot control

Connect the plug of the foot control to the connecting socket (2) of the sewing machine and to the wall socket. The sewing speed is regulated by pressing the foot control.

You can regulate the sewing speed by moving the slide on the front part of the foot control.

Position ► = half speed

Position ►► = full speed

AE023 - 120V, USA and Canada

AE020 - 230V, Europe

AE024 - 240V, Australia

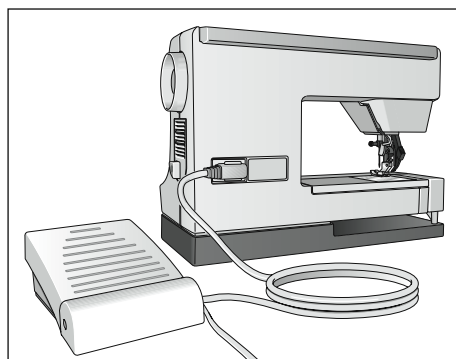

## Main switch

Press the main switch (1) to turn on power and light. The sewing machine is now ready to use.

*Note: Your select™ sewing machine is adjusted to provide the best stitch result at normal room temperature. Extreme hot and cold temperatures can affect the sewn result.*

### For the USA and Canada

This appliance has a polarized plug (one blade wider than the other). To reduce the risk of electric shock, this plug is intended to fit in a polarized outlet only one way. If the plug does not fit fully in the outlet, reverse the plug. If it still does not fit, contact a qualified electrician to install the proper outlet.

**DO NOT** modify the plug in any way.

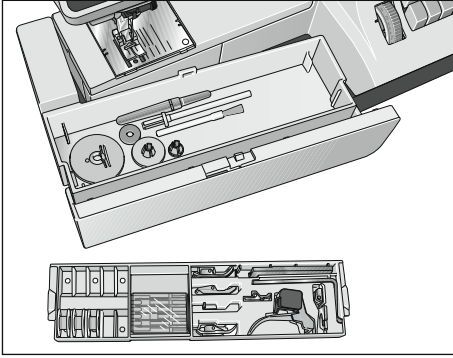

## Accessory tray

Your PFAFF® select™ sewing machine has a removable accessory tray (16) which is also used as an extended work support.

Model 4.2, has a special removable accessory organizer. The enclosed accessories are numbered. Sort the enclosed accessories into the corresponding sections of the accessory organizer.

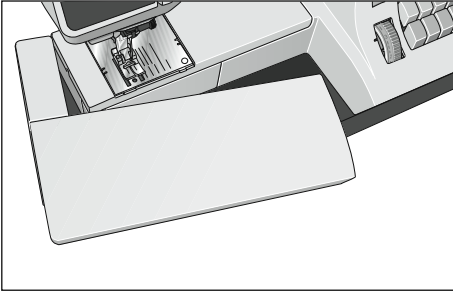

## Using the free arm

In order to sew using the free arm, swing the accessory tray to the left and lift it upwards out of the hole.

When replacing the tray, make sure it is flush with the free arm of the sewing machine.

## Bobbin winding

### Preparing the machine for bobbin winding

Hold the handwheel (4) firmly and turn the handwheel release disc (3) until it stops in the direction of the arrow. This stops the needle from moving while the machine is winding the bobbin.

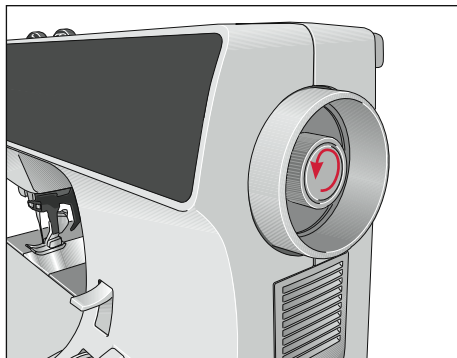

### Placing the bobbin



Switch off the main switch (1)

Place the empty bobbin so that the small pin (A) of the bobbin winder (6) snaps into the slot of the bobbin. The PFAFF® logo is facing up.

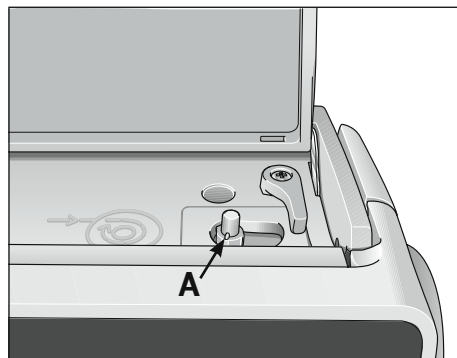

Push the bobbin to the right

*Note: The bobbin can only be wound when it is moved fully to the right.*

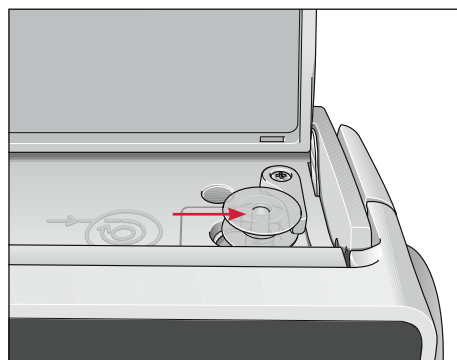

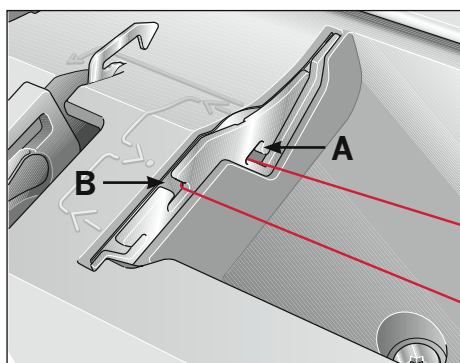
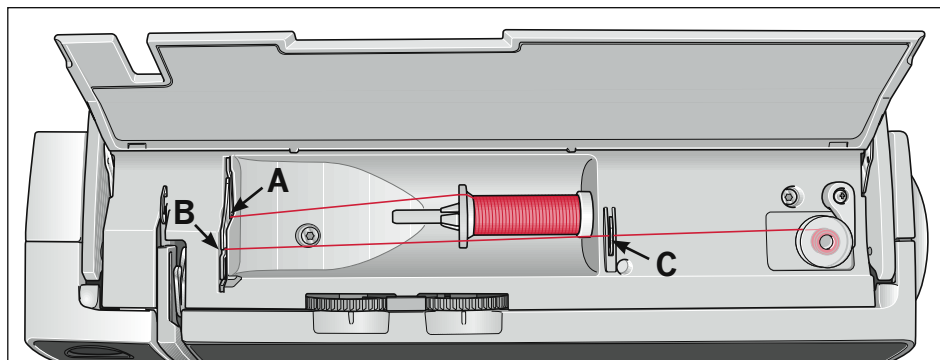

## Winding the bobbin from the spool pin

Place the sewing thread on the spool pin (9). To guarantee free movement of the thread and to give additional hold to the thread spool, fit a spool cap corresponding to the size of the thread spool.

### Threading

Place the thread into guide A and pull it through opening B and to the right under the hook C. Wind the thread clockwise a few times around in the bobbin.

### Winding

Switch on the main switch (1). Hold the end of the thread firmly and press the foot control. The winding action will stop automatically as soon as the bobbin is full. Cut the thread, push the bobbin to the left and remove it.

### Don't forget:

Turn the handwheel release disk (3) fully back again. Then turn the handwheel (4) towards you until it snaps into place.

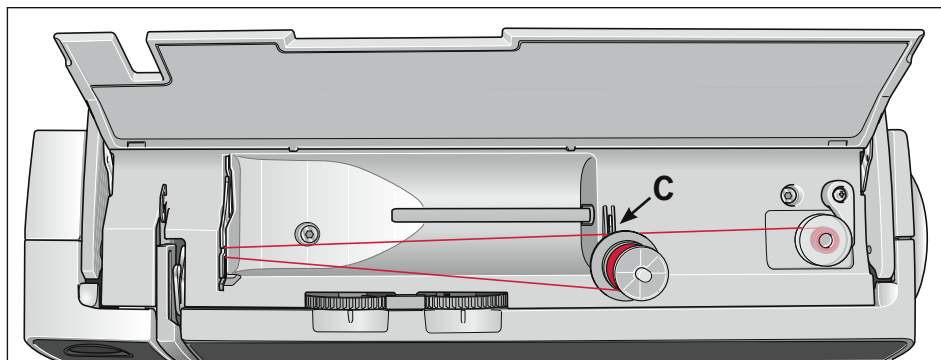

## Winding the bobbin from the second spool pin

Push the second spool pin (8) into its hole. Slide on a spool cap and place the thread spool on the spool pin.

### Threading

Place the thread into guide A and pull it through opening B to the right under hook C. Wind the thread clockwise a few times around the bobbin.

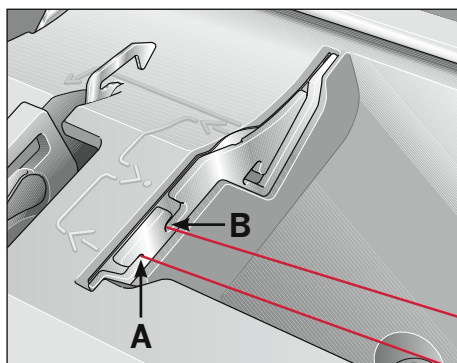

### Winding

Switch on the main switch (1). Hold the end of thread firmly and press the foot control. The winding action will stop automatically as soon as the bobbin is full. Cut the thread, push the bobbin to the left and remove it.

### Don't forget:

Turn the handwheel release disk (3) back again. Then turn the handwheel (4) towards you until it snaps into place.

*TIP: If the machine is already threaded, you can easily wind thread from the second spool pin without having to unthread the machine.*

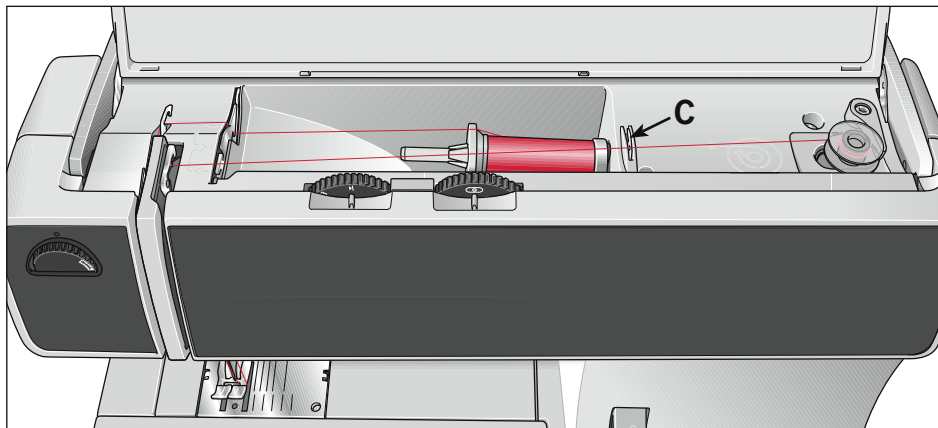

## Winding through the needle

Even if the machine has been completely threaded, you can still wind the bobbin. First make sure to stop the needle from moving while winding the bobbin (see page 12).

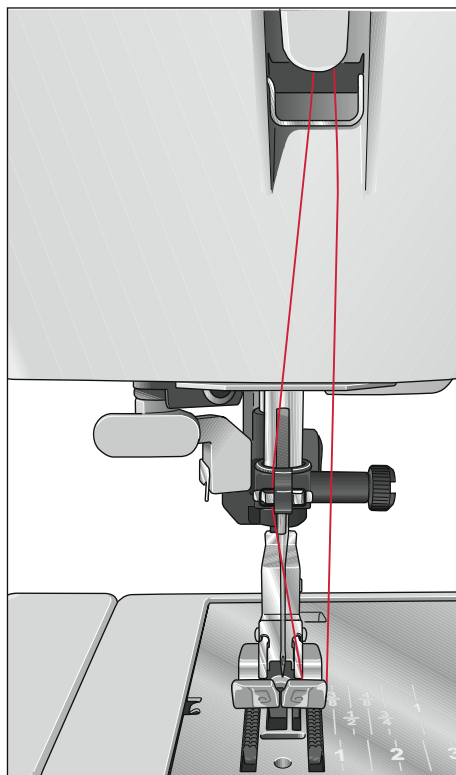

## Threading

Raise the presser foot lifter (15). Pass the needle thread through the presser foot and then upwards through the right threading slot (12).

Now, pull the thread into the take-up lever from left to right (10). The take-up lever must be positioned at its very top.

Pass the thread to the right under the hook C. Then wind the thread several times around the bobbin.

## Winding

Switch on the main switch (1) and press the foot control. The winding action will stop automatically as soon as the bobbin is full. Cut the thread, push the bobbin to the left and remove it.

## Don't forget:

Turn the handwheel release disk (3) back again. Then turn the handwheel (4) towards you until it snaps into place.

## Changing the bobbin



Switch off the main switch (1)

### Removing the bobbin case and bobbin

Open the bobbin door at the left side swinging it open towards the front. Lift the latch (E) of the bobbin case and pull the bobbin case out of the machine. Release the latch and take the empty bobbin out of the bobbin case.

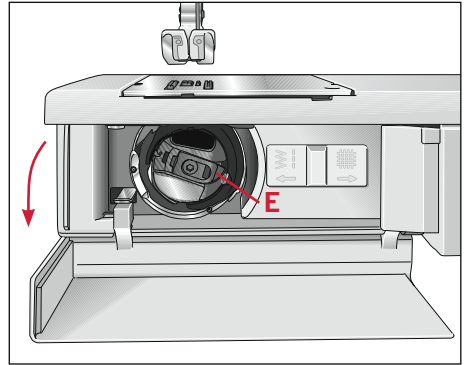

### Inserting the bobbin

Insert the full bobbin (with the PFAFF® logo facing towards the bobbin case) into the bobbin case. In doing so, pull the thread sideways through slot A, then under the tension plate B until it rests in the opening (see arrow).

*Check: Hold the bobbin case with the bobbin facing towards you. When you pull the thread, the bobbin must turn clockwise.*

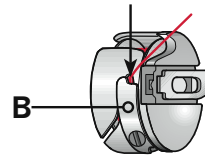
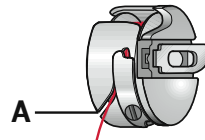
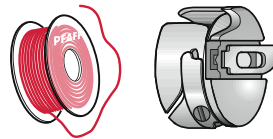

### Inserting the bobbin case

Lift latch E and slide the bobbin case onto the hook pin C as far as it will go. Opening D of the bobbin case must face upwards.

*Check: Pull the bobbin thread sharply. The bobbin case must not fall out of the hook.*

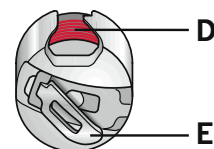
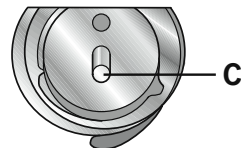



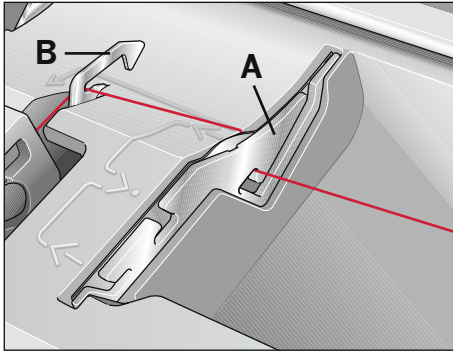

## Threading

### Threading the needle thread



Switch off the main switch

Raise the presser foot lifter (15) and turn the handwheel until the take-up lever (10) has moved to the top. Place the thread on the spool pin (9) and fit the corresponding spool cap.

Now, using both hands, pull the thread into guide A and under thread guide hook B. Pass the thread through the lefthand threading slot C and downwards. Pull the thread around stop D into the righthand threading slot and upwards E to the take-up lever F.

The thread must be pulled into the take-up lever F from left to right and downwards again in the right hand threading slot. Floss the thread from the side behind one of the two thread guides H.

To thread the needle, stick the thread from front to back through the needle eye.

To thread the needle using the needle threader, please refer to the next page.

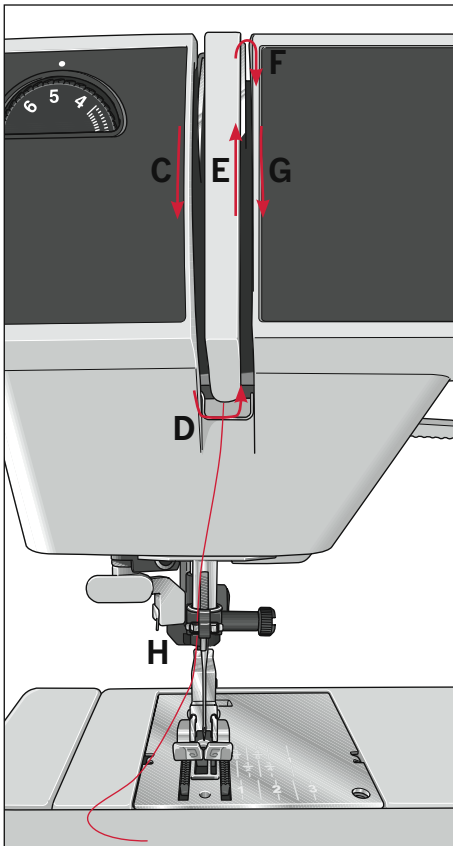

## Needle threader (Model 4.2)

To make threading the needle easier and quicker, use the PFAFF® needle threader (22). Lower the presser foot. Turn the handwheel until the needle is at its highest position. Place the needle thread under hook A and hold it taut. Move the needle threader fully downwards and turn it towards the needle so that the small hook B goes through the needle eye. Place the thread into the hook from below.

Turn the needle threader towards the rear, releasing the thread carefully, and allow the threader to move upwards. You can now pull the thread through the needle eye.

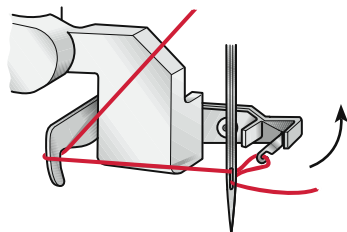
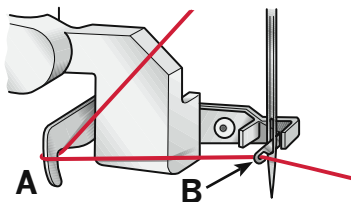

## Threading the twin needle

Insert the twin needle.

Fit the second spool pin and place one spool of thread on each pin.

In the left threading slot (12) you will find tension disk C. During threading, make sure that you pass one thread left and one thread right over tension disk C.

Carry on threading in the usual way, but make sure the threads are not twisted with each other.

Pull the threads right and left into thread guide (23) and thread the needles.

*Note: You cannot use the needle threader for a twin needle.*

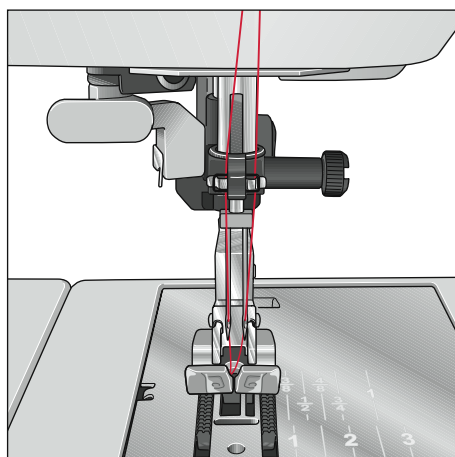
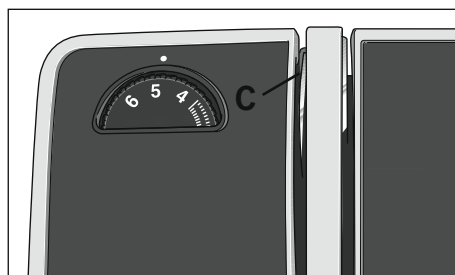

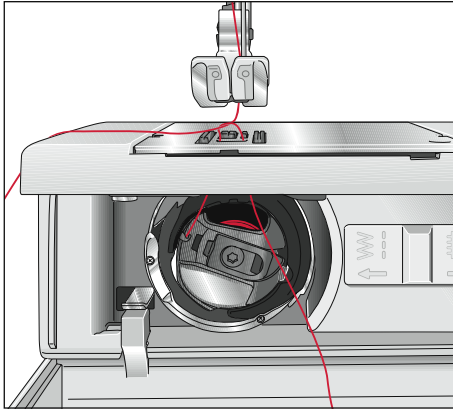

## Bringing up the bobbin thread



Switch off the main switch (1)

Raise the presser foot. Hold the needle thread and turn the handwheel towards you until the needle is in the highest position and the bobbin thread has formed a loop. Pull the needle thread to bring up the bobbin thread.

Close the bobbin case/hook cover and pull the thread under the presser foot to the left.

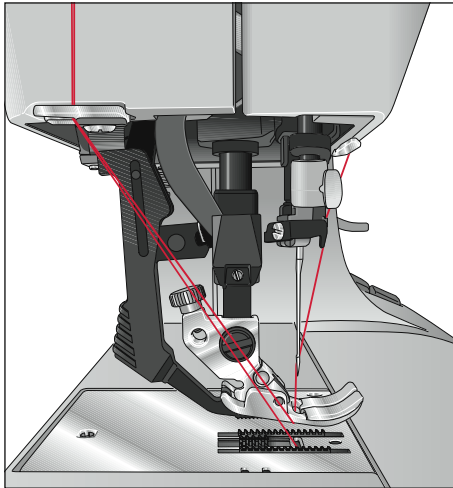

## Thread cutter

Pull the threads from the back to the front over the thread cutter (13).

## Presser foot lifter

The presser foot is raised or lowered with the presser foot lifter (15).

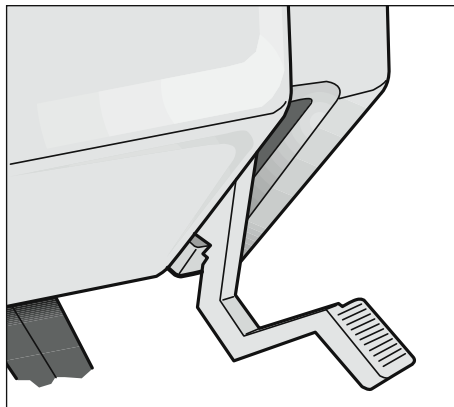

## Changing the presser foot

### Removing the presser foot

 Switch off the main switch (1)

Position the needle at its highest point. Press the presser foot upwards at the front and down at the back at the same time so that it disengages from the presser foot holder (26).

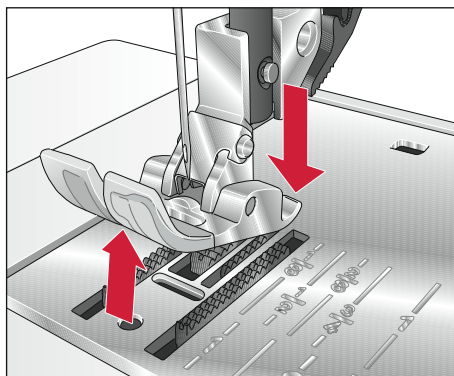

### Engaging the presser foot

Place the presser foot under the presser foot holder (26) so that when the presser foot lifter (15) is lowered, the pins of the foot engage in the presser foot holder.

*Check: Please check that the presser foot is properly engaged by raising the presser foot lifter.*

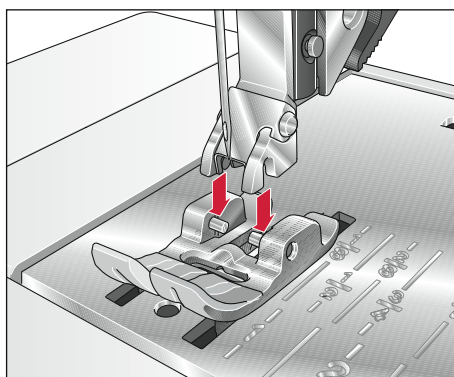

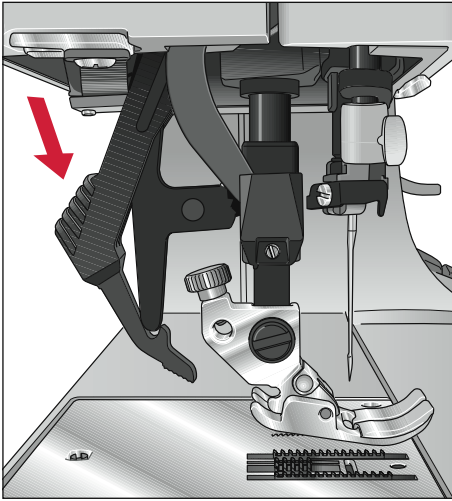

## The IDT™ system (Integrated Dual Feed)

For sewing any fabric precisely PFAFF® provides the ideal solution: the Integrated Dual Feed, IDT™ system.

As on industrial machines, the IDT™ system feeds the fabric from the top and bottom at the same time at the same stitch length. The fabric is fed precisely.

On light fabrics such as silk or rayon the dual feed prevents puckering of the seam.

The even feeding action also ensures perfect matching of checked and striped fabrics. The IDT™ system keeps all layers of quilt projects aligned to prevent stretching of the top layers.

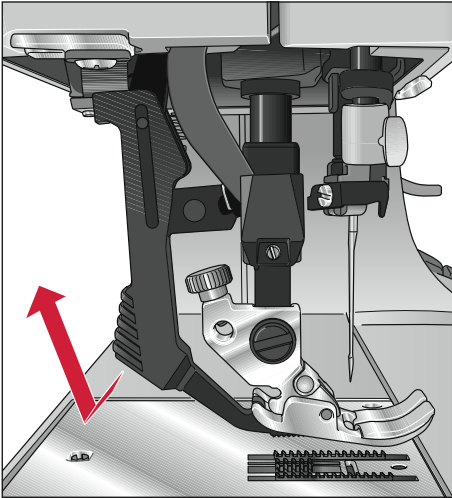

### Engaging the IDT™ system

Raise the presser foot. Press the IDT™ system down until it engages.

**Important!** For all work with the Integrated Dual Feed IDT™ system, use presser feet with the center back cut-out.

### Disengaging the IDT™ system

Hold the Dual Feed with two fingers at the ribbed ankle. Press the IDT™ system down, then pull it away from you and release the IDT™ system slowly upward.

## Changing the needle

 Switch off the main switch.

**To remove:** Lower the presser foot and move the needle to its highest point. Now loosen the needle screw (25) and pull the needle down.

**To insert:** The flat side A of the needle must face to the rear. Lower the presser foot and insert the needle, pushing it up as far as it goes. Hold the needle and tighten the needle screw (25) firmly.

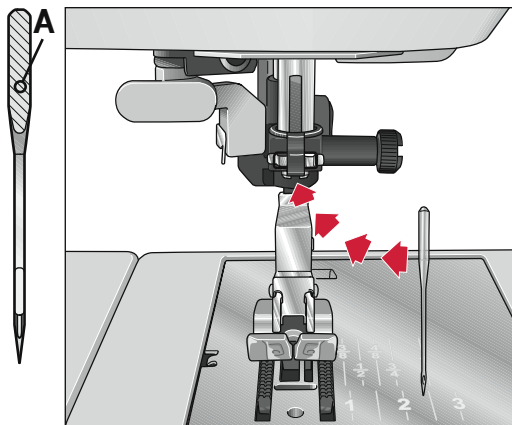

## Setting the needle thread tension

Set the required needle thread tension (11) with the help of the mark B.

The normal setting for sewing is 4 to 5.

For free-motion sewing, darning and buttonhole set the tension between 2 and 3.

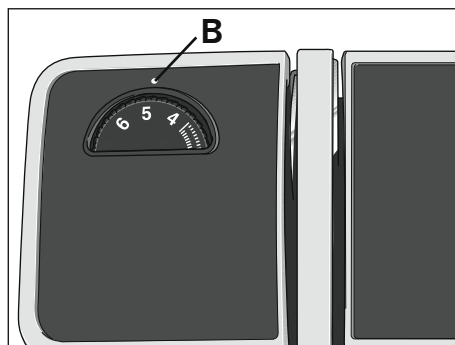

## Dropping the feed dog

For certain sewing work, e.g. darning or free-motion sewing the feed dog has to be dropped.

To do this, open the bobbin case/hook cover and move slide C fully to the right. Now the feed dog is dropped.

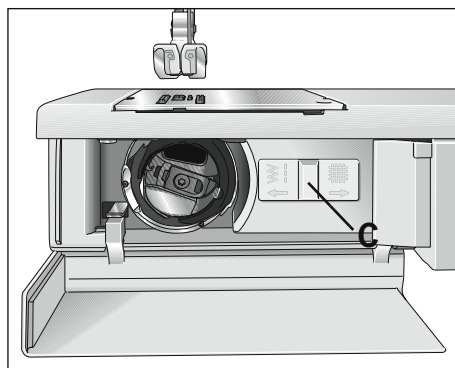

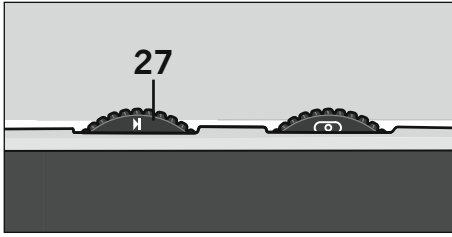

## Stitch width dial

The stitch width can be adjusted with this dial (27). When selecting the width, the needle must not be in the material.

**Basic setting:** Turn the stitch width knob (27) to the symbol ► (maximum stitch width).

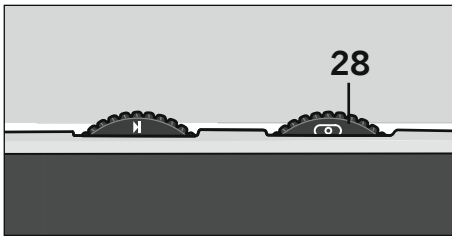

**Exception:** Straight stitch is sewn with stitch width 0.

In chapter “2. Utility stitches and practical sewing”, you will find recommendations in the tables for the stitch width selection of individual stitches. During sewing you can also change the stitch width.



## Needle position dial

In the center needle position  14 additional needle positions can be selected by turning the needle positioning dial (28) in increments to the left or right.

The furthest needle position to the left  can be achieved by turning the dial (27) as far as it will go to the right. The furthest needle position to the right  can be achieved by turning the dial as far as it will go to the left. When the position of the needle is being changed, the needle must not be in the material.

*Note: If you have selected the right needle position, you can now use the width dial (27) to increase or reduce the width of the left side of the stitch. The reverse applies also for needle position to the left.*

## Reverse sewing

The machine sews in reverse only as long as the reverse sewing button (20) is pressed.

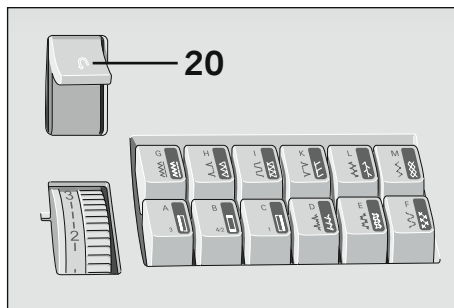

## Stitch length adjustment dial

### Adjust stitch length

With the stitch length adjustment dial (19) you can adjust the stitch length between 0 and 6 mm by turning the point marking on the button to the required length.

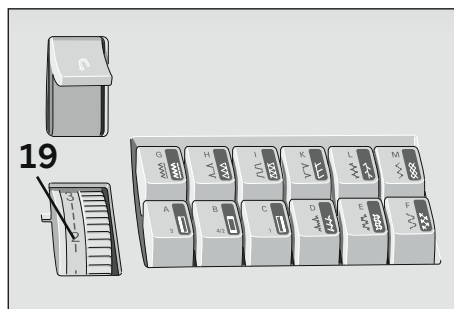

## Buttonhole

Between the numbers 0 and 1 you will find the "buttonhole" symbol (A). This area is the optimum stitch density for sewing buttonholes and embroidering.

The further you turn the dial to 0, the higher the density of the stitch.

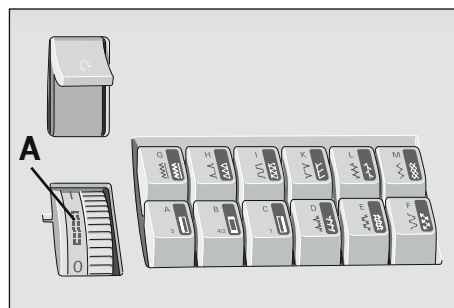

## Stretch stitches

To sew stretch stitches (dark background), you must turn the stitch length adjustment dial (19) as far as it will go in the grey area.

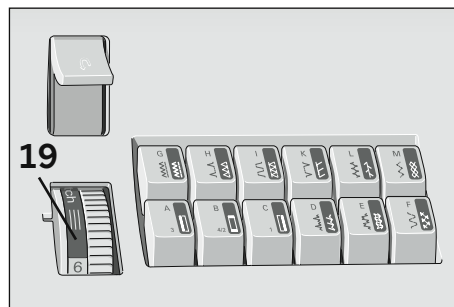



## Stitch selection Easy Select System

### Utility stitches

Each stitch has been given a letter that you can find on the push button controls. By pressing the correct button, the stitch is selected and the machine is ready to sew. Button B releases the buttons that have been activated.

Under the lid (7) you will find the stitch table with all the utility stitches and stitch combinations.

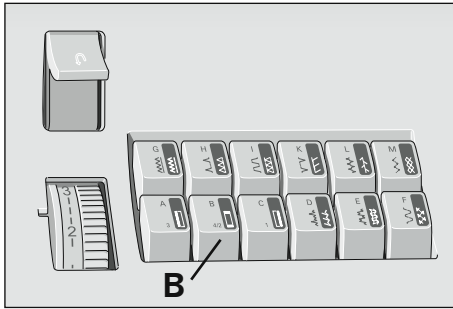

### Stretch stitches

All the stitches with a colored background are stretch stitches, i.e. they are suitable for stretch material. Press the selected button down and turn the stitch length dial (19) as far as it will go in the grey area (A).

Button B releases the button that have already been selected.

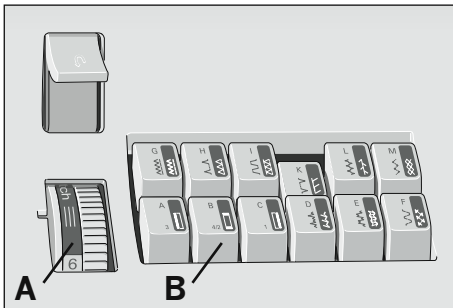

### Utility and stretch stitch combinations

By pushing two or several buttons you can create combinations in the utility stitch range.

The stitch length dial can either be in the normal sewing range or in the stretch range.

All the stitch combinations are illustrated on the stitch table in the lid. You can release buttons that are already activated with button B.

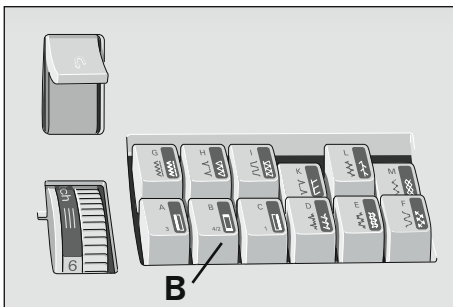







## Explanation of the sewing chart







The following charts show the recommended settings for each stitch or technique.

These charts also provide you with instructions that are necessary when sewing the selected stitches.

The choice of the sewing foot, the setting of the needle thread tension and whether to use IDT™ system or not.

Always use the “center” needle position  if not otherwise specified in the instructions.

	Stitch					
4.2						
3.2						
2.2				-		

Stitch	Stitch number
	Stitch width in mm
	Stitch length in mm
	IDT™ system on=  off= 
	Thread tension
	Presser foot number

Some fabrics have a lot of excess dye which can cause discoloration on other fabric but also on your sewing machine. This discoloring may be very difficult or impossible to remove.

Fleece and denim fabric in especially red and blue often contain a lot of excess dye.

If you suspect that your fabric/ready-to-wear garment contains a lot of excess dye, always pre-wash it before sewing/embroidering to avoid the discoloring.



*Perfect tension*



*Too high tension*



*Too low tension*

## Needle thread tension

To get perfect sewing results, the needle and bobbin thread tensions must be perfectly tuned to each other. The normal setting for utility stitches is in the range of 4-5.

Check the tension with a wide zigzag stitch. The threads must be interlaced between the two fabric pieces.

If the needle thread tension is too high the threads are interlaced above the top fabric. If the needle thread tension is too low, the threads are interlaced below the lower fabric.

The adjustment of the needle thread tension is described on page 22.

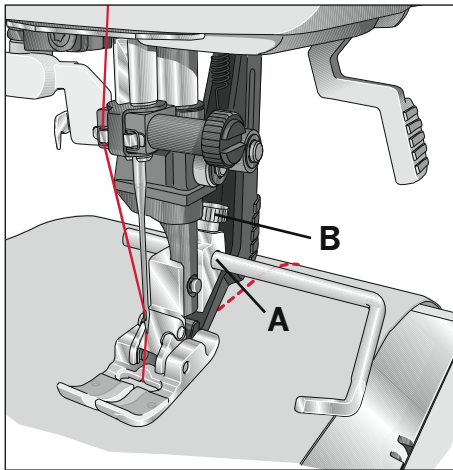

## Topstitching

Straight stitch G can be sewn using any of 15 various needle positions in such a way that you can always guide the sewing foot along the fabric edge for top-stitching work. The top-stitch needle position is determined by the needle position dial. If you wish to top-stitch farther from the fabric edge, simply guide the fabric along the guide marks on the needle plate or use the edge guide (standard accessory No.8). The edge guide is inserted into hole A and is secured with fixing screw B.





## Straight stitch

Stitch G is the basic straight stitch. The stitch length can be increased up to 6 mm.

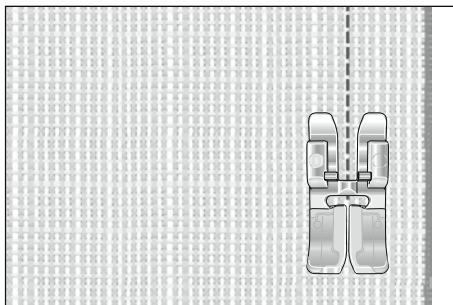
It is easier to do some sewing jobs by changing the needle position, e.g. top-stitching a collar or sewing in a zipper. You can select up to 15 different needle positions.

Please ensure that the needle is at its highest position when adjusting the needle position.



	Stitch					
<b>4.2</b>	G	0	2.5	●	3-5	0/1
<b>3.2</b>	G	0	2.5	●	3-5	0/1
<b>2.2</b>	G	0	2.5	-	3-5	0/1

## Zigzag stitch

In addition to overlock stitching, zigzag stitch G, stitch width 5 ▶, is also suitable for overcasting various materials. In this case, the material should only be positioned halfway under the sewing foot.

When overcasting the edge, make sure the needle goes into the material and over the edge alternately.





The width for overcasting can be reduced up to 2 mm.

For overcasting difficult materials, blind stitch foot No. 3 is very useful. When sewing, the thread lies over pin C, thus preventing curling of the fabric edge. In this way you can sew beautiful smooth seams.

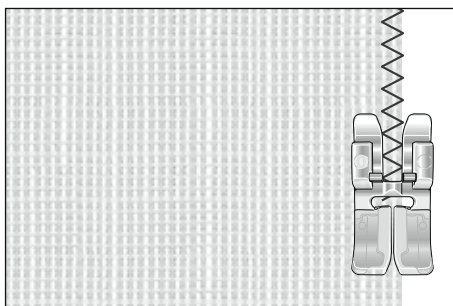
The raw edge must be guided along edge guide B. You can adjust this edge guide with adjusting screw A.





**Important!** When the blindhem stitch foot is used for overcasting with the zigzag stitch, select the right needle position. Choose a stitch width in the range of 3-5 mm (do not use any other needle position).

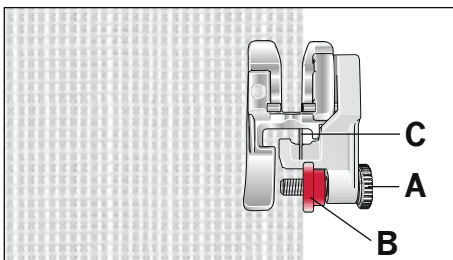

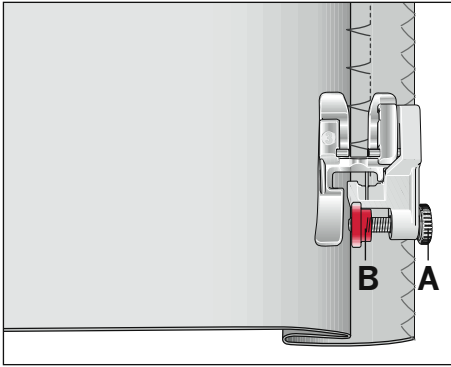
	Stitch					
<b>4.2</b>	G	2-▶	1-2	●	3-5	0/1
<b>3.2</b>	G	2-▶	1-2	●	3-5	0/1
<b>2.2</b>	G	2-▶	1-2	-	3-5	0/1





	Stitch					
<b>4.2</b>	D/H	5- ▶	1-2	●	3-5	0/3
<b>3.2</b>	D/H	5- ▶	1-2	●	3-5	0/3
<b>2.2</b>	D/H	5- ▶	1-2	-	3-5	0/3

## Blindhem stitch

The blindhem stitch is best suited for invisible hems; sewing by hand is no longer necessary. Use Blindhem stitch H for wool fabrics and Blindhem stitch D for stretch fabrics. For Blindhem stitch D the hem is sewn and overcast at the same time.

- Serge the edge of the hem (only necessary for stitch H).
- Fold the edge inwards by the hem width.
- Now unfold the hem again so that the hem edge protrudes by about 1 cm
- Place the fabric under the sewing foot so that the crease line runs along edge guide B.
- Using the needle positioning dial (28), select the needle position to the right .
- When the needle enters the crease line, it must only pick up one fiber of the fabric.

### Remember!

If the stitches are visible on the right side, adjust edge guide B by turning adjusting screw A.

*Tip: If you chose to sew Blindhem stitch H or Blidhem stitch D with stitch width less than 5, use foot nr.0.*

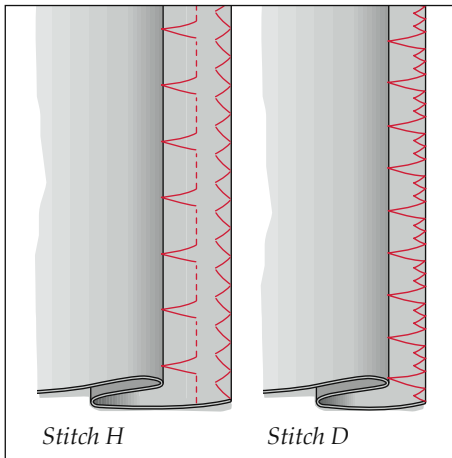

Stitch H

Stitch D

## Overlock stitch

### What is an overlock stitch?

For stretch fabrics, the select™ models offer overlock stitches which sew two fabric layers together and overcast simultaneously. They are more elastic than normal seams, very durable and quickly sewn.

*Tip: We recommend using blindhem stitch foot No. 3 when sewing overlock seams. It guides particularly well and prevents the seam from puckering even on wide seams. Also remember to set the red marker on the foot to the right position. This to guide the fabric edge.*

### Open overlock stitch (K)

With this stitch, thicker fabrics and fabrics which do not fray too much can be sewn together perfectly.

*Tip: Make sure that the needle sews to the right of the fabric just over the edge and not in it.*

### Closed overlock stitch (I)





The closed overlock stitch is perfect for sewing jersey knits. You can also sew sleeve cuffs and knit collars which are well-sewn and long-lasting.

*Tip: Ensure that the sleeve cuff is stretched while it is being sewn.*

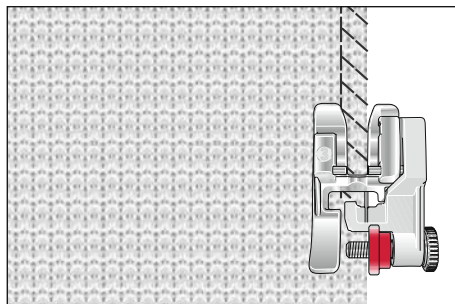



### Remember!

When overlocking, if you select stitch width other than 5 ▶, make sure the needle does not strike the bar of sewing foot 3.

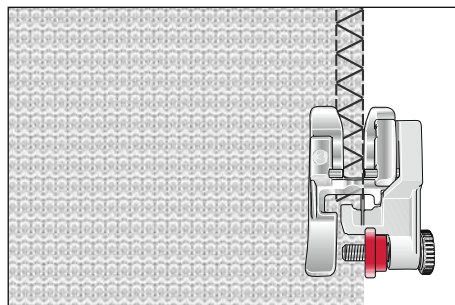

	Stitch					
<b>4.2</b>	K	5-▶	stretch	●	3-5	0/3
<b>3.2</b>	K	5-▶	stretch	●	3-5	0/3
<b>2.2</b>	K	5-▶	stretch	-	3-5	0/3





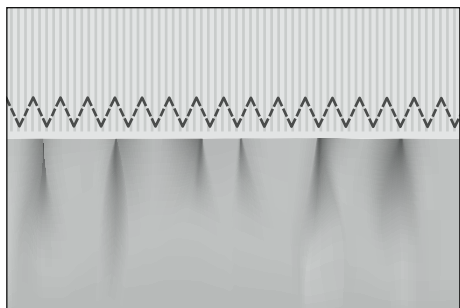

	Stitch					
<b>4.2</b>	I	5-▶	stretch	●	3-5	0/3
<b>3.2</b>	I	5-▶	stretch	●	3-5	0/3
<b>2.2</b>	I	5-▶	stretch	-	3-5	0/3



## Elastic stitch

Because of its high elasticity, this stitch can be used for sewing elastic on swimwear, skirts or lingerie.

- Mark elastic and fabric in quarters.
- Pin elastic to fabric at quarter markings.
- Place fabric and elastic under sewing foot.
- Stretch elastic to fit the fabric. Begin sewing.

	Stitch					
<b>4.2</b>	M	5-▶	1-2.5	●	3-5	0/1
<b>3.2</b>	M	5-▶	1-2.5	●	3-5	0/1
<b>2.2</b>	M	5-▶	1-2.5	-	3-5	0/1



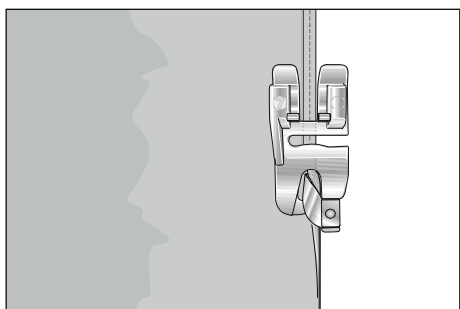

*Note: When stretching elastic, make sure to stretch from the front and back of the sewing foot.*



## Stabilizing edges

With the rolled hem foot you can hem blouses, silk scarves and valances with ease, without having to pre-iron the fabric edges. The hemming prevents the edges from fraying and a clean, durable edge is the result.

- Fold the beginning of the fabric edge over twice (approx. 2 mm)
- Lay the folded fabric edge underneath the hemmer and sew a few stitches.
- Leave the needle in the fabric, raise the presser foot and insert the fabric into the rolled hem foot scroll.
- Lower the presser foot and guide the fabric evenly into the rolled hem foot.

	Stitch					
<b>4.2</b>	G	0	3	●	3-5	7
<b>3.2</b>	G	0	3	●	3-5	optional
<b>2.2</b>	G	0	3	-	3-5	

Take care that the fabric does not run under the right half of the presser foot.

*Tip: On silk, Bastiste and chiffon fabrics, the roll hem is particularly attractive with a zigzag stitch*

## Hemming with the twin needle

Use the twin needle to make beautiful topstitch seams.

Using the twin needle you can add a professional touch to hems on stretch fabrics such as T-shirts, knitted articles or cycling shorts both quickly and easily.





Twin needles are available in different widths. The traditional width for topstitching is 4 mm. To prevent the needle from striking the needle plate, you must make sure that you select the center needle position .

- First fold and iron the width of fabric desired for the hem.
- Then topstitch the hem from the right side.
- Finally, cut the protruding hem edge back to the seam.

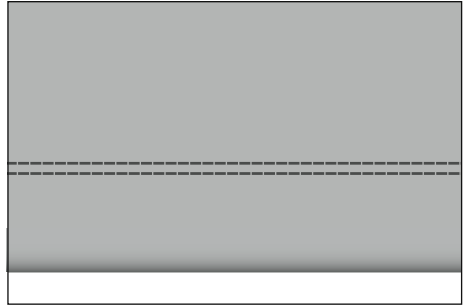







Use only a stretch needle when sewing stretch fabric!

*Tip: On difficult fabrics such as ribbed knitwear it is advisable to baste the hem before topstitching it.*



	Stitch					
<b>4.2</b>	G	0	3	●	3-5	0/1
<b>3.2</b>	G	0	3	●	3-5	0/1
<b>2.2</b>	G	0	3	-	3-5	0/1

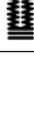
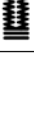

	Stitch					
<b>4.2</b>	CBA	5-▶		○		5
<b>3.2</b>	CBA	5-▶		○		5
<b>2.2</b>	CBA	5-▶		-		5

## Buttonholes

Sewing buttonholes is very easy with all the models with push button controls since the fabric does not have to be turned.

Buttonholes are generally sewn onto a piece of doubled fabric. However, for some fabrics, e.g. silk, organza and viscose, it is necessary to use stabilizer to prevent the fabric from contracting while sewing.

To produce beautiful seams, embroidering or darning threads are ideal.

Mark the starting point of the buttonhole either with a magic pen or dress pin, and always sew a sample buttonhole first.

*Note: Before starting any buttonhole, always push the guide of the buttonhole foot fully to the front, i.e. so that the red arrow is at the first red mark. The red marks are arranged at an interval of 0.5 cm. They are a guide when determining the length of the buttonhole.*

### Standard buttonhole

- Insert the buttonhole foot and slide the foot forward as far as it will go.
- Select stitch 1 (C) and sew the right side of the buttonhole to the required length. Clip the top thread after a few stitches.
- Select stitch 2 (B) and hold the button down as you sew a few bartacks.
- Select stitch 3 (A) and sew the left side of the buttonhole until it matches the previous side in length.
- Select stitch 4 (B) and hold the button down as you sew a few bartacks.
- Release button B and sew a couple stitches to secure your buttonhole.

- Carefully cut open your buttonhole.

*Tip: For fine buttonholes, you can reduce the buttonhole width with the stitch width dial (27) down to approx. 3 mm. Use the center needle position .*

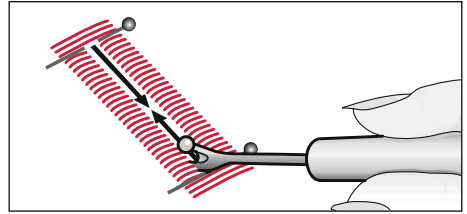

*Carefully cut open your buttonhole with scissors or a seam ripper.*

## Standard buttonhole with gimp thread

To sew especially durable buttonholes, on heavy fabrics, knits or sportswear, we recommend using a gimp thread.

On knits the gimp thread is particularly important to prevent the buttonhole from stretching.

- Lay the gimp thread over the rear protrusion A and pass the thread ends underneath the presser foot towards the front.
- Clamp the threads to the left and right of protrusion B.
- Slide the buttonhole runner as far forwards as possible and sew the buttonhole as described for your select™ model.
- Pull the loop of the gimp thread into the buttonhole and cut the threads.

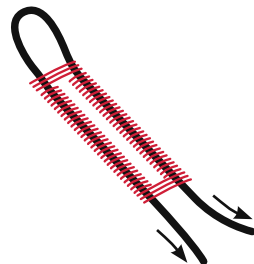
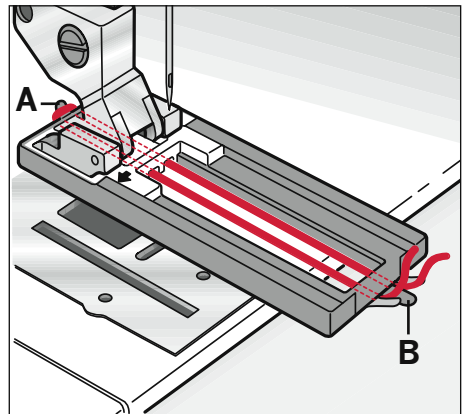

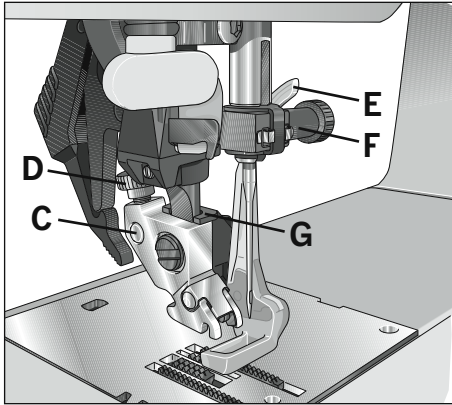

## Free Motion Sewing

### Insert the darning foot:





Loosen screw D. Set the needle at its highest point and push the pin of the darning foot fully into the hole C of the sewing foot holder. When doing this, the guide fork G should position itself around the presser bar. The lever E must be behind the fixing screw F. Now tighten screw D.

### Free Motion Position:

Lower the presser foot lifter (A) while pushing it lightly to the rear. This snaps the presser foot lifter into a notch (B) on the back side of the sewing machine into the free motion position.

- Drop the feed dog.
- Select a straight stitch or a zigzag stitch.
- Keep an even speed, manually move your fabric.

*Tip: For even stitches, move your fabric at a smooth even flow. Move the fabric so the stitching does not cross.*

	Stitch					
<b>4.2</b>	G	-	-	○	2-3	6
<b>3.2</b>	G	-	-	○	2-3	optional
<b>2.2</b>	G	-	-	-	2-3	

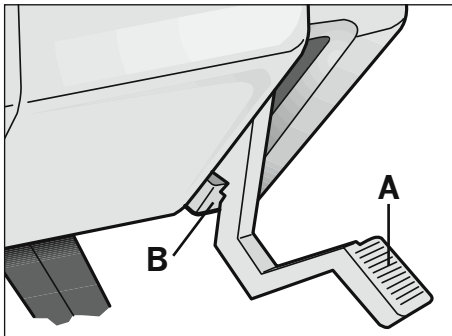

## Sewing on buttons

With zigzag stitch G (stitch width 4 mm) you can sew on two and four hole buttons.





- Remove the sewing foot and lower the feed dog.
- Turn the handwheel towards you and move the button so that the needle enters the left hole in the button.
- Now lower the presser foot lifter; this holds the button in place.

- Sew on the button. Take care to ensure that the needle also enters the right-hand hole in the button.

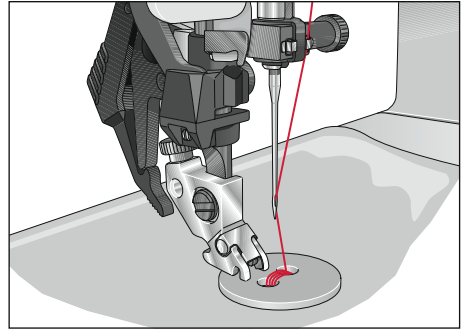
## Securing

- Select straight stitch by turning the width dial (27) to 0.
- Change the needle position with the needle position dial (28) so that the needle enters one of the two holes.
- Sew a few securing stitches.



	Stitch					
<b>4.2</b>	G	4	-	○	2-3	-
<b>3.2</b>	G	4	-	○	2-3	-
<b>2.2</b>	G	4	-	-	2-3	-

## Sewing on zippers

There are various methods of sewing on zippers. For skirts, we recommend the fully concealed zipper, for men's and ladies' trousers the semi concealed zipper. Various zippers are available. We recommend using a metal zipper for strong fabrics such as denim. For all other fabrics we recommend a plastic zipper.

It is important for all types of zippers to sew very close to the edge of the teeth of the zipper. This is why it is possible to insert the zipper foot either on the right or the left of the presser foot holder.



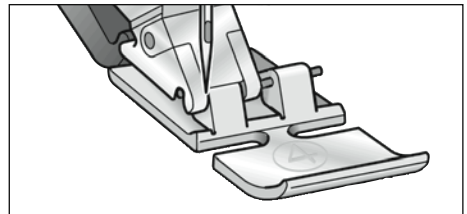

You can set the needle so that it enters close to the edge of the zipper teeth by using one of the 15 available needle positions. If the foot is engaged to the right, the needle must only be moved to the right. If the foot is engaged left, the needle must only be moved to the left.

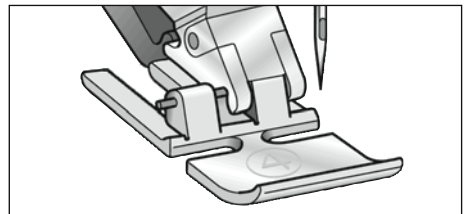

*Left presser foot position*



*Right presser foot position*

	Stitch					
<b>4.2</b>	G	0	3	●	3-5	4
<b>3.2</b>	G	0	3	●	3-5	4
<b>2.2</b>	G	0	3	-	3-5	4

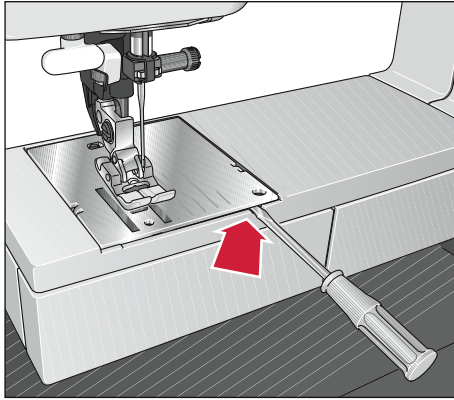

## Changing the needle plate

 Switch off the main switch (1)

It is very important to clean your sewing machine, because it will reward you with a longer service life. The more often you use the machine, the more care it needs.

### Removal:

- Raise the sewing foot and remove the removable accessory tray.
- Push the point of a small screwdriver into the opening between needle plate and sewing machine.
- Twist it lightly to the right and the needle plate will snap half way out of its mounting. Now push the screwdriver into the left opening and take the needle plate out.

### Replacing:

- Place the needle plate on flat at the back and push it down with both hands at the front until you hear it snap in place. Before you start sewing, check that the needle plate is lying flat.

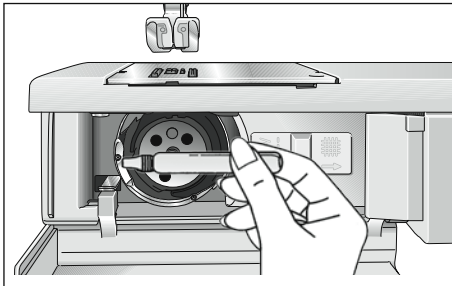
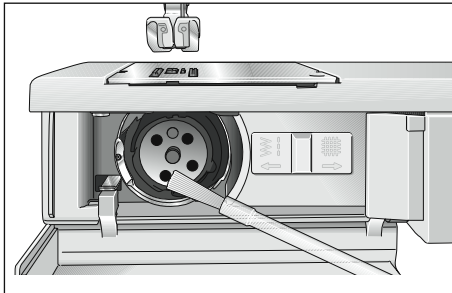

## Cleaning and oiling

 Switch off the main switch (1)

- Remove the needle plate and lower the feed dog.
- Clean the feed dog and hook area with the brush.
- Apply a drop of oil (every 8 hours of operation) to the hook as shown in the illustration.

*Note: Use good quality sewing machine oil only!*

## Trouble-shooting

### The machine skips stitches

The needle is not properly inserted.	Push needle fully upwards, flat side facing the back.
The wrong needle is inserted.	Use a needle system 130/705 H.
Needle is bent or blunt.	Insert a new needle.
Machine is not properly threaded.	Check how machine is threaded.
Needle is too small for thread.	Use a larger needle.

### Needle thread breaks

See reasons above.	See above.
Thread tension is too tight.	Adjust thread tension.
Thread is poor or has slubs in it, or has become dry after too-long storage.	Only use good threads.
Thread is too thick.	Use needle with large eye (System 130 N).

### Needle breaks off

Needle is not pushed fully in.	Insert new needle and push fully in.
Needle is bent.	Insert new needle.
Needle is too thick or too thin.	Insert new needle.
Needle is bent, and has hit the needle plate because you are pulling or pushing the fabric.	Let the machine feed the fabric. Only guide the fabric lightly.
The bobbin case is not properly installed.	When you insert the bobbin case, push it fully into the stop.

### Seam is sewn unevenly

The tension needs adjusting.	Check top and bottom tensions.
Thread is too thick, slubbed or hard.	Only use perfect threads.
The bobbin thread is unevenly wound.	Do not wind thread free-hand, but run it on through the winding tension.
Thread bunching at top or bottom side of fabric.	Thread up correctly. Check needle and bobbin thread tensions.

## Machine does not feed or feeds irregularly

Sewing lint has collected between the feed dog teeth rows.

Remove needle plate, remove lint with brush.

Feed dog is lowered, slide A (see page 22) at right.

Push slide B (see page 22) to left.

## Machine is running with difficulty

There are thread remnants in the hook race.

Remove the threads.

### Important note!

Before you replace sewing feet or needles, you must switch off the main switch.

Do not start the threaded machine without fabric in it.

If you leave the machine, even for a short time, do not forget to switch off the main switch. This is important if children are nearby.

We reserve the right to change the machine equipment and the assortment of accessories without prior notice, or make modifications to the performance or design.

Such modifications, however, will always be to the benefit of the user and the product.

## Intellectual property

PFAFF and IDT (image) are trademarks of KSIN Luxembourg II, S.ar.l.



Please note that on disposal, this product must be safely recycled in accordance with relevant National legislation relating to electrical/electronic products. If in doubt please contact your retailer for guidance

CE - Authorised Representative

VSM Group AB, **SVP Worldwide**  
Drottninggatan 2, SE-56184, Huskvarna, SWEDEN

